

A simulation study for the virtual commissioning of the CERN central helium liquefier

Rogez E., Bradu B., Moraux A., Pezzetti M., Gayet P., Coppier H.¹

CERN, 1211 Geneva 23, Switzerland

¹LMBE, ESIEE, BP100 80082 Amiens Cedex 2, France

This paper describes the implication of dynamic simulation in cryogenics processes. The simulation aims to prepare plant commissioning and operation, and to validate the efficiency of the new process control logic. PLC programs have been tested on a process simulator integrating physical models of valves, heat exchangers, turbines, phase separator, and helium data. The model has shown the capacity to reproduce cold-box dynamic behaviour, from 300 K to 4.5 K.

INTRODUCTION

The CERN cryogenics experimental infrastructure includes several cryogenic plants controlled by ABB-Master PLCs (automation Swiss company). These plants are spread through out different experimental areas around the CERN sites.

In order to ensure safety and reliability as required by the operation team, to enhance ease of operation and to provide long-term durability, CERN has undertaken a major upgrade using the experience gained during the construction of the LHC cryogenic control system within the UNICOS framework [1].

Virtual commissioning has already shown its benefits on other large scale industrial systems such as LNG (Liquefied Natural Gas) plants [2] but has never been implemented on cryogenic plants due to the large functional span and the non-linearities involved. Our motivation takes its origin in the important time saving factor during plant re-start by minimizing unexpected errors in the program producing undesired process behaviour.

The work described in this paper focuses on the interaction between a cryogenic process simulator, a PLC and its supervision. It presents control adaptation problems on a simulator integrating physical models of valves, heat exchangers, turbines, phase separator and helium data. The entire model encompasses 2700 equations and has the capacity to reproduce the cold-box dynamic behaviour from 300 K to 4.5 K.

SIMULATION PRINCIPLES

Simulation architecture

CERN has developed a simulation environment for cryogenic processes called PROCOS (Process & Control Simulator) to perform dynamic simulations for operator training, control optimization and control validation [3]. This environment uses the same three layers control architecture as the real processes, see Figure 1. In simulation, the Cryogenic Process Simulator (CPS) is a C++ application embedding a model of the process in order to provide simulated input/output to the control layer. The Process and Logic Controllers (PLC) are replaced by PLC emulators provided by PLC manufacturers. The data server and supervision clients remain the same. All components are communicating on the Ethernet network using an OPC[®] protocol.

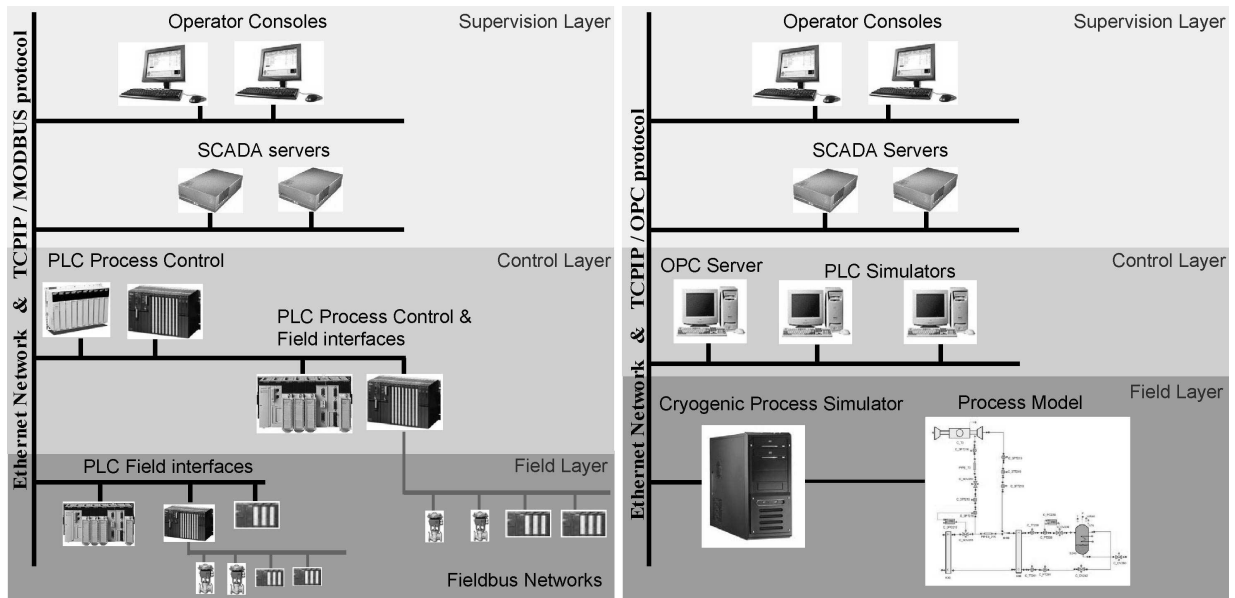

Figure 1 The real and the simulated control architecture for cryogenic processes

Process models

Models are designed with EcosimPro[®] 4.4, a commercial modelling and simulation software allowing to develop dynamic models from differential and algebraic equations. Cryogenic systems are modelled using an object-oriented approach where each cryogenic equipment is an independent model. The models are based on thermodynamic and hydraulic equations. Helium properties are taken from data tables calculated offline with the specialized HEPAK[®] library. In this way a cryogenic library including all components (heat exchangers, turbines, valves, phase separators, pipe, compressors...) used at CERN cryogenic installations was developed.

PROCESS DEFINITION AND MODEL

Central liquefier - Cold-Box TCF50

The CERN Central Liquefier plant produces all year long liquid helium at 4.5 K for distribution via mobile dewars to CERN-wide users. The helium liquefier is composed of several units:

- A compressor station which compresses gaseous helium from 1.1 bar to 12.5 bar.
- A TCF50 coldbox provided by Linde[®] cooling down helium from 300 K until 4.5 K with a 2 g/s liquefaction rate. The scheme of the coldbox is shown in Figure 2.
- An intermediate 5000 l dewar to stock the liquid helium before distribution in small dewars.
- A liquid helium distribution box dispatching the helium dewars.

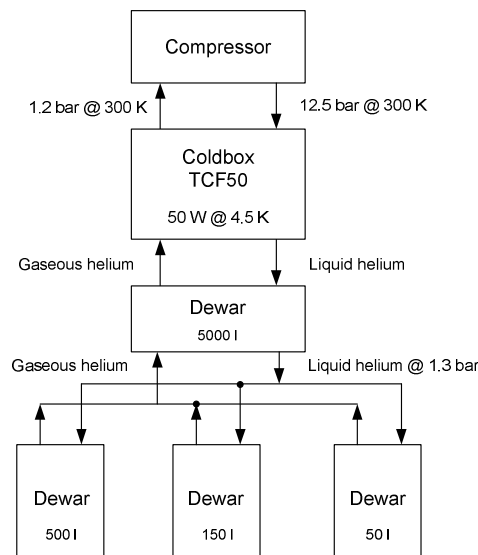

Figure 2 The CERN central liquefier

The compressor pressure is auto-controlled and can provide 80 g/s of helium to the coldbox at room temperature. The cold box circuit consists of 6 heat exchangers, 2 turbines and a Joule-Thomson valve, see Figure 3. The speeds of the turbines are controlled at around 3400 Hz.

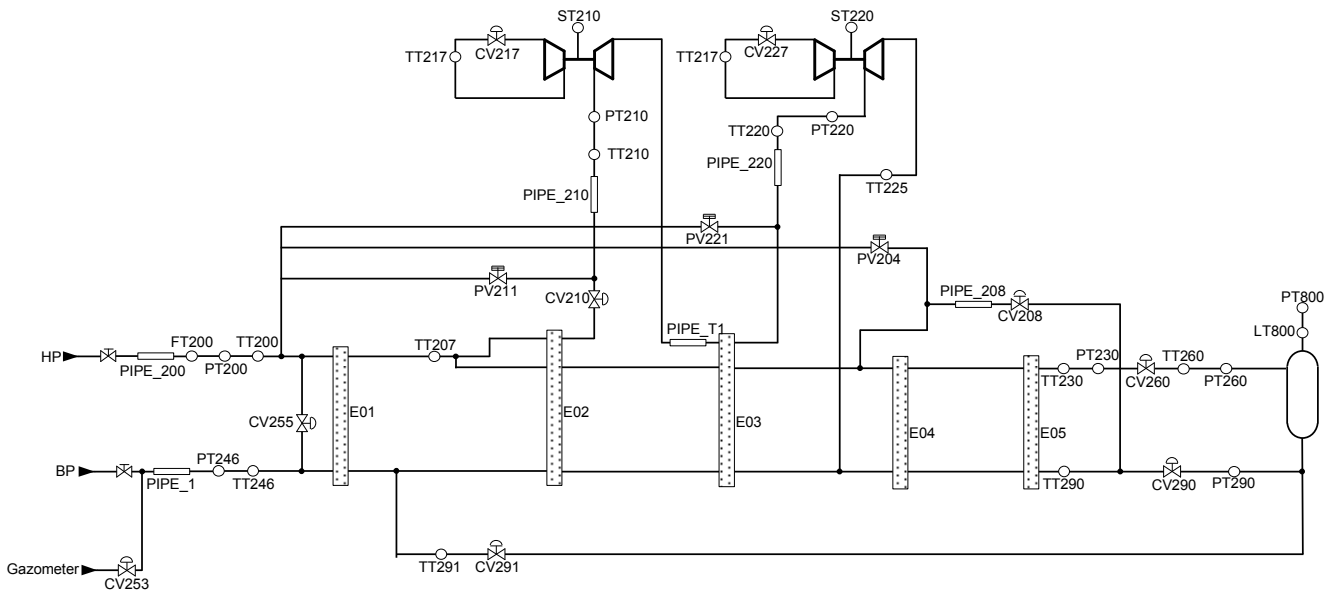

Figure 3 The TCF50 model

Model generation

For our study, we have limited the simulation to the critical part of the installation. In this way, only the coldbox and the intermediate cryostat have been modelled. We consider that the compressor station and the vacuum system work perfectly under constant boundary conditions.

In order to proceed to the virtual commissioning, the simulated coldbox behaviour must be as close as possible to the reality. For this reason, the model needs all the mechanical and cryogenic parameters. Heat exchangers are defined by their nominal pressures, massflows, internal volumes and masses. Turbine models use the nominal values of speed, temperature, pressure, isentropic efficiency and power extracted by the break circuits. Pipes and dewars take as parameters their respective length, diameter, height and heat loss, and valve are modelled according to the valve coefficients (Cv or Kv).

Using the CERN cryogenic component library, process modelling consists in reproducing the process architecture by object drag and drop on the Ecosimpro graphical interface. Regarding the TCF50 technical datasheet and the modifications achieved on the apparatus to obtain a liquid helium production unit, component parameters have been adjusted in the simulation model to fit with the real plant dynamics.

A SIMULATOR AS AN OFFLINE COMMISSIONING TOOL

The simulation process is calculated by 2 Intel Dual-core 1.86 GHz with 2 GB of RAM. One is dedicated to the process and the PLC simulator, and the other is used for the SCADA part (PVSS, process visualization and control system software) and the OPC[®] Server.

Once the process simulation model has been finished, the data collected from the real cooldown achieved under the ABB PLC have been compared with the simulated data. In a second time, after the completion of the installation, we have done the comparison between the real plant and the simulation to confirm the quality of the model. The results are shown in the Figures 6, 7 and 8.

Based on know-how control specifications for such plants, the ABB control logic was transformed into a standardized structure, taking into account process singularities. Afterwards, the offline commissioning performed on the new control logic through the simulator allowed to correct and optimize the new PLC programs. Consequently, the control logic of the bypass valve, CV208, the Joule-Thomson valve, CV260, and the return valve, CV290, has been adjusted and validated. To enhance turbine safety, a new turbine program has been developed and checked using simulations. Therefore, the control of the

inlet valve and the brake circuit were modified, implying a review of valve ramp slopes, and turbine security interlocks. The previous and new turbine start sequence can be seen in Figures 4 and 5.

The offline commissioning also focused on the validation of PI controllers. According to the simulated responses, PI coefficients have been tuned and the reversed action parameters, allowing the inversion order from controller to the valves, have been tested and verified.

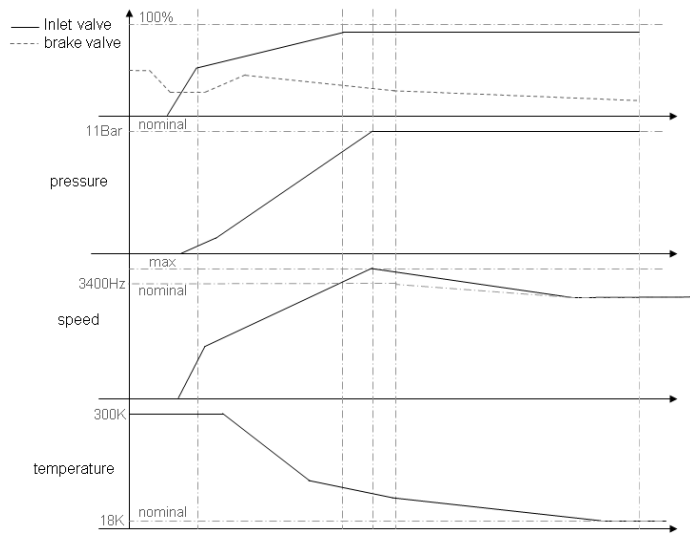

Figure 4 Turbine former control start sequence

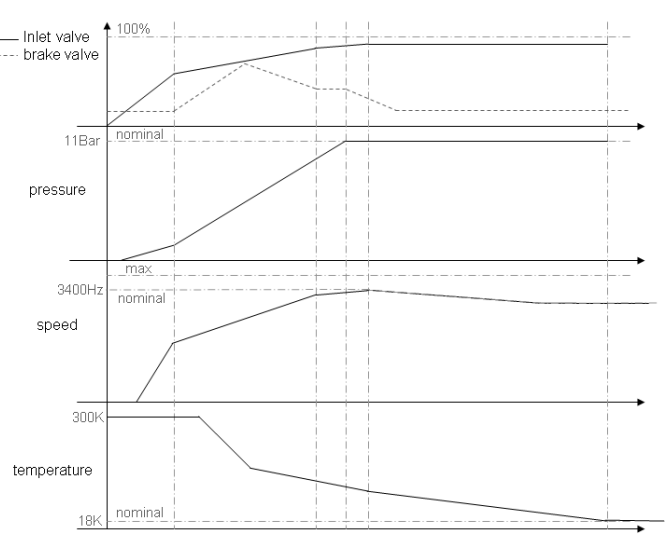

Figure 5 Turbine new control start sequence

The different simulated temperatures, pressures and massflows agree with the ones observed during the cooldown from 300 K to 4.5 K, see Figure 6 and 7 where the temperature after the first heat exchanger (TT207), the temperature after the second turbine (TT225) and the total massflow obtained in simulation are plotted and compared. The simulation is around 5 times faster than the real time which is a relevant simulation speed for such a system.

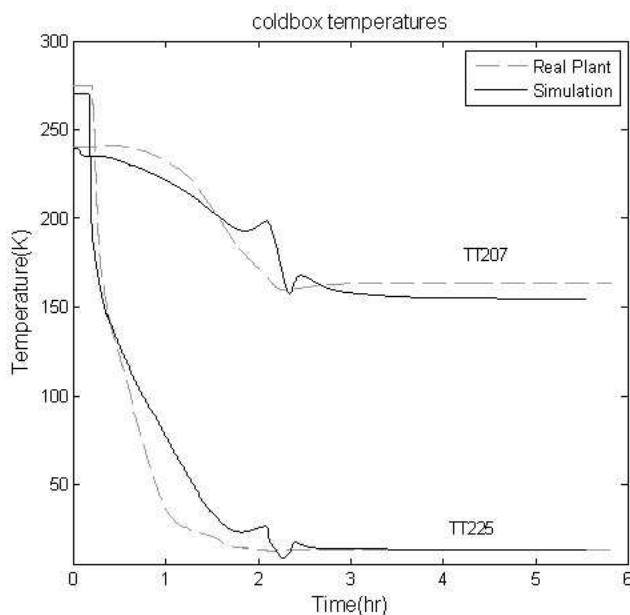

Figure 6 Coldbox temperatures

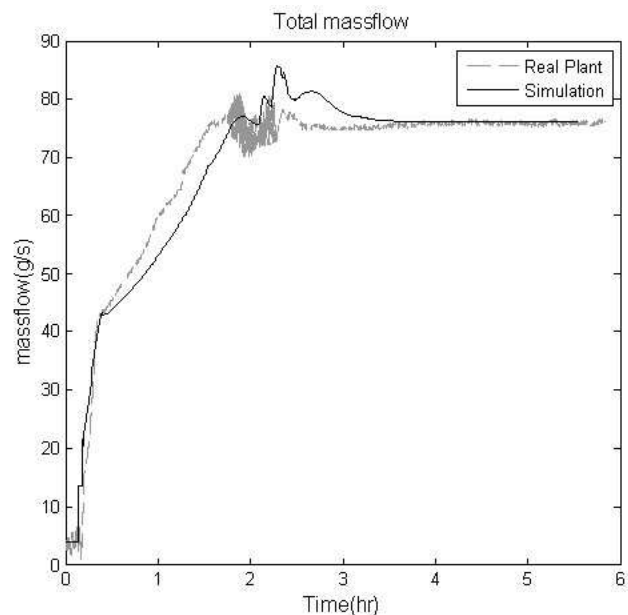

Figure 7 Total mass flow

The simulated behaviour of the turbines is closed to the real turbine dynamics, see Figure 8. Therefore, the turbine model used for the virtual commissioning reacts correctly. In the simulator, a small difference in the power of the brake circuit results in an amplification of the controller working on the brake valve but does not affect the turbine operation.

We can observe on Figures 6, 7 and 8 a disturbance after 2 hours of simulation. This difference between the simulation and the real plant corresponds to the Joule-Thomson valve opening which leads to a different process reaction in simulation. This modification of the valve position provides a flow

modification in the dewar and a return of warm gaseous helium in the coldbox. This difference does not have any impact on the virtual commissioning which is not disturbed by undesired control interlock.

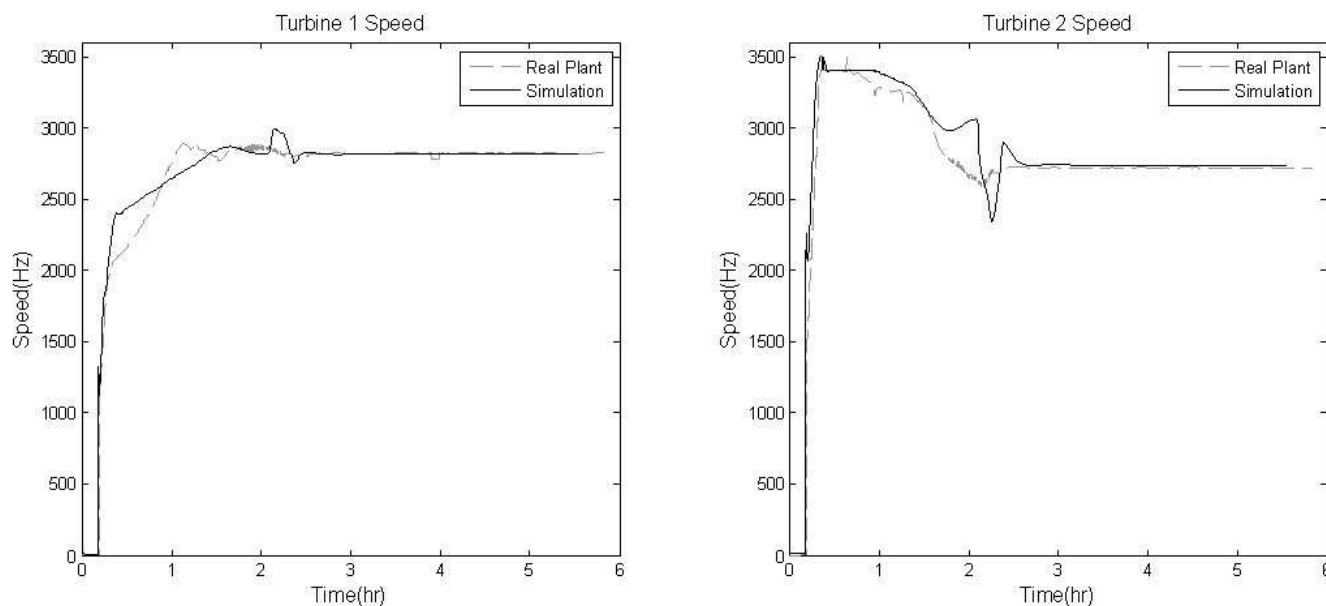

Figure 8 Turbine speeds

CONCLUSION AND PERSPECTIVES

Within the UNICOS framework, a dynamic simulator able to reproduce large-scale refrigeration plant behaviour has been used to perform a pre-commissioning of the entire control system. Based on our experience on cryogenic plant commissioning [4, 5], we were able to assess the utility of the simulator environment. This virtual commissioning minimizes the time for plant re-start and allows operators to anticipate unforeseen plant reactions, using it as a training test bench.

The encouraging results obtained have clearly shown that we are able to avoid programming mistakes and perform control optimization through simulations. A long term perspective will consist in using the simulation environment to explore different control algorithms applied to the cryogenic systems.

ACKNOWLEDGMENTS

Acknowledgments are addressed to Michel Cugnet, from ALLS Consortium for his highly appreciated contribution on cryoplant cryogenic process and also to Dominique Legrand, Richard Baud, Felix Bettens and Roland Guyon, from CERN AT/CRG, for their effort during all different phases of the project.

REFERENCES

1. Casas-Cubillos, J., Gayet, P., Gomes, P., Sicard, C.H., Pezzetti, M., Varas, F.J., Application of Object-based Industrial Controls for Cryogenics, EPAC'02, Paris, June 2002
2. Krause, H., Virtual commissioning of a large LNG plant with the DCS 800XA by ABB, 6th EUROSIM Congress on Modelling and Simulation, Ljubljana, Slovenia (2007)
3. Bradu, B., Gayet, P., Niculescu, S.I., Modeling, simulation and control of large scale cryogenic systems, International Federation of Automatic Control World Congress, Seoul, Korea (2008)
4. Perinic, G., Pezzetti, M., Dupont, T., Legrand, D., Installation and commissioning of the helium refrigeration system for the CMS Magnet, IEEE Trans. Appl. Supercond. (2004) 14 1708-1710
5. Passardi, G., et al., Commissioning of the Cryogenic System for the ATLAS Superconducting Magnets, AIP Conf. Proc. (2004) 710 168-175